



i3

**TWEETER**

**USER MANUAL**

---

ENGINEERED IN GERMANY

---

# Congratulations!

Dear Customer,

Congratulations on your purchase of this high-quality product.

HELIX COMPOSE highlights best quality, excellent manufacturing and state-of-the-art sound quality.

Thanks to more than 30 years of experience in research and development of audio products HELIX COMPOSE sets new standards in the car audio speaker market.

We wish you many hours of enjoyment with your new HELIX COMPOSE components.

Yours

AUDIOTEC FISCHER Team

## General instructions

### General instructions for installing HELIX loudspeakers

To prevent damage to the speakers and possible injury, read this manual carefully and follow all installation instructions. This product has been checked for proper function prior to shipping and is guaranteed against manufacturing defects.

For a proper performance and to ensure full warranty coverage, we strongly recommend to get this product installed by an authorized HELIX dealer.

If you choose to perform your own installation read the following information and precautions carefully.

Failure to follow the stated precautions may result in personal injury and / or damage to the audio system or vehicle.

1. Always make sure that the speaker will fit into the intended mounting location and that there is adequate depth for the magnet system.
2. Check for adequate space between speaker and window, window crank, power window mechanism, seat, rear deck torsion bars, and other items which may interfere with the speaker's mounting. This is very important if any hole cutting is required. Detailed size information is indicated in the dimension section of this manual. Take care that the mounting surface is flat and free from all obstructions.
3. Ensure that the loudspeakers are correctly connected in polarity. Exchanging plus and minus may result in significant loss of sound quality. The positive leads of the loudspeakers are marked red.
4. Make sure that all speaker wiring is fully protected from cutting or wear at sharp edges, which can lead to short circuits that may damage your head unit, amplifier and / or speaker system.

5. Verify that all connection wires are long enough in order to avoid any mechanical stress on the wires or the connectors.
6. Make sure that all components are mounted properly.
7. Do not mount the components where water may splash on them.
8. The quality of the installation has a significant effect on the overall performance of the speaker system. Treat each installation step with a high degree of attention.
9. Avoid low frequency cancellation caused by air leakage between the speaker basket and the mounting surface (e.g. mounted on a bended or uneven surface or mounted in an oversized hole).
10. Mounting panel reinforcement may be necessary in some cases in order to ensure a stable, torsion-free and even surface. This can be achieved by mounting the speaker on a metal, plastic or wooden sub-baffle behind the body or door panel. Consult an installation specialist for further advices.
11. In most cases you can use the original speaker mounting locations in the doors, A-pillars, body panels or the rear deck. If these are not available you have to prepare your own secure installation place. Due to their structural integrity and accessibility the precut mounting holes should be used whenever possible. Information on a proper mounting can be found in the section "Installation" of this manual.

**IMPORTANT:** Never cut any metal that is an integral part of an automobile's safety or structural car body.

We strongly recommend that you operate the complete audio system at low volume before final installation. So you can check whether each speaker is working before securing the loudspeakers into their mounting locations.

## Find your composition

Go to [www.audiotec-fischer.com/compose](http://www.audiotec-fischer.com/compose) to explore the whole HELIX COMPOSE platform



# Installation

## Mounting

**Option a:**  
Flush mount

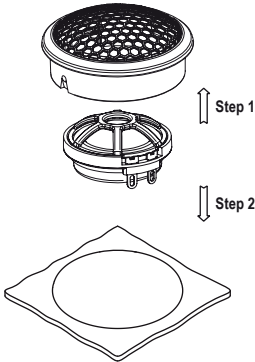

**Option b:**  
Angle mount

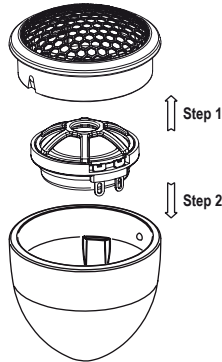

**Option c:**  
Professional integration with optionally available **FlexMount 20** car-specific adaptor\*

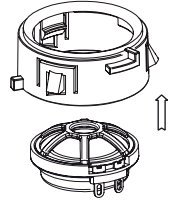

\*Contact your retailer or visit [www.audiotec-fischer.com/compose](http://www.audiotec-fischer.com/compose) for an up-to-date overview of available **FlexMount 20** car-specific adaptors.

## Wiring

**Universal connection e.g. in active applications**

Cut off the plug and connect it to the signal source.



**Connection to HELIX COMPOSE i3 Crossover (optionally available)**



Ensure that all components are correctly connected (phase), i.e. plus to plus and minus to minus. The positive leads of the loudspeaker system are marked with a red stripe.

# Technical data

## Without housing

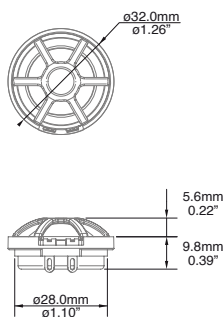

## With housing for flush mount

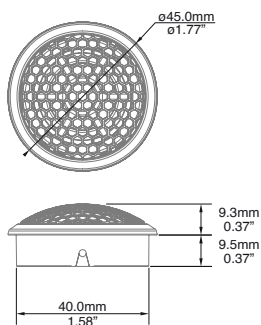

## With housing for angle mount

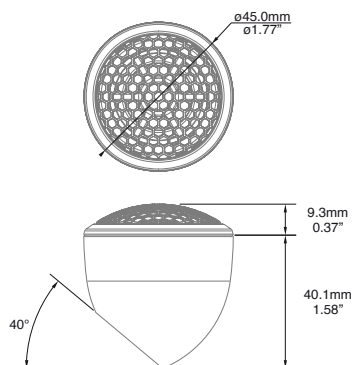

		Ci3 T20FM-TI
Impedance	$Z$	4 $\Omega$
DC resistance	$R_e$	3.2 $\Omega$
Frequency response		2.000 Hz - 25.000 Hz
Resonance frequency	$F_s$	1800 Hz
Sensitivity	$SPL$	91.0 dB @ 2.83V / 1m 88.0 dB @ 1W / 1m
Voice coil diameter	$\varnothing$	20 mm
Cone material		Titanium

## FlexMount 20

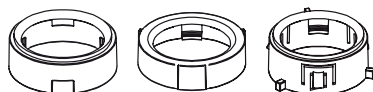

The optionally available **FlexMount 20** car-specific tweeter adaptor rings allow a tailored and acoustically optimized adaption of the HELIX COMPOSE tweeters to the vehicles original mounting location.

Contact your retailer or visit [www.audiotec-fischer.com/compose](http://www.audiotec-fischer.com/compose) for an up-to-date overview of available adaptors.

## Recommended crossover frequencies for the highpass

Slope	Minimum crossover frequency
6 dB/Octave	> 5.000 Hz
12 dB/Octave	> 3.500 Hz
24 dB/Octave	> 3.000 Hz

## Correct disposal of this product

(Applicable in the European Union and other countries with separate collection systems)

If you want to dispose this product, do not mix it with general household waste. There is a separate collection system for used electronic products in accordance with legislation that requires proper treatment, recovery and recycling. Contact your local government office for details in locating a recycle facility close to you. Proper recycling and waste disposal will help conserve resources and prevent detrimental effects on our health and the environment.

## Warranty disclaimer

The warranty service is based on the statutory regulations. Defects and damage caused by overload or improper handling are excluded from the warranty service. Any return can only take place following prior consultation, in the original packaging together with a detailed description of the error and a valid proof of purchase. Technical modifications, misprints and errors excepted! For damages on the vehicle and the device, caused by handling errors of the device, we can't assume liability. All HELIX speakers are tagged with a CE-Certification mark. Thereby these devices are certified for the use in vehicles within the European Community (EC).

**AUDIOTEC  
FISCHER**

AUDIOTEC FISCHER GmbH  
Hünegräben 26  
57392 Schmallenberg  
Germany

Made in China  
**CE EAC UK CA**