

G.T.集团保留对所示产品进行修改或改进的权利,恕不另行通知 - 所示产品的可用性可能会更改 - 本用户指南中描述的产品仅代表 **AUDIO** 产品的一部分 - 所有品牌和商标均仅用于描述目的,所有权利属于各自所有者 - 全部或部分,禁止复制本用户指南。

G.T.trading reserves the right to make modifications or improvements to the products illustrated without notice thereof - The availability of the products illustrated is subject to change - The products described in this User's Guide represent just a part of the **AUDIO** products available - All brands and trademarks mentioned have been used exclusively for description purposes and all rights belong to the respective owners - Total or partial reproduction of this User's Guide is prohibited.

*GT*trading
AUDIO
SYSTEM
Italy
ASS90.4

使用指南
四声道
汽车音响功率放大器
USER'S GUIDE
Four-channel
car audio power amplifier

中文

简介

感谢您选择此音响设备来满足您的功放需求。近年来功放已被大大改善，确保其质量和可靠性。每个产品都应用了最新的技术，为您提供难以置信的音效和无与伦比的音质。简洁，高度发达的电路有助于低失真和极高的效率。这就是为什么我们确信您的新功放将为您提供良好体验的价值。

GB

INTRODUCTION

Thanks and congratulations for choosing this mobile audio for your amplification needs. The amplifiers have been significantly improved throughout years to assure quality and reliability. The latest technology has been incorporated into every product providing you with incredible power and unparalleled sound quality. Our simple, highly developed circuitry contributes to low distortion and the ultimate in efficiency. That's why we are sure that your new amplifier will provide you with a sound value you can enjoy for years to come.

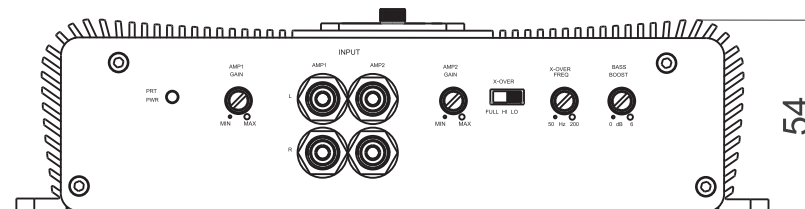
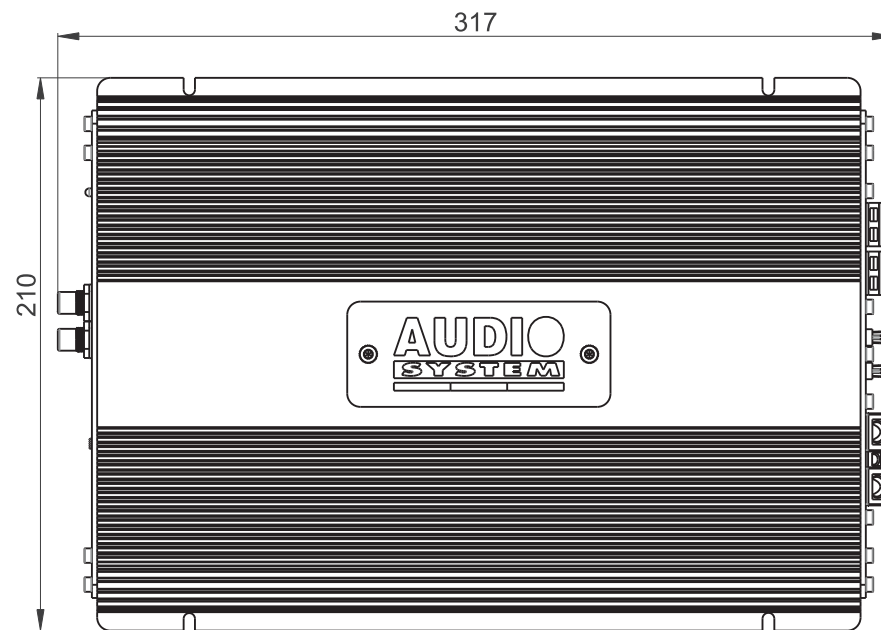
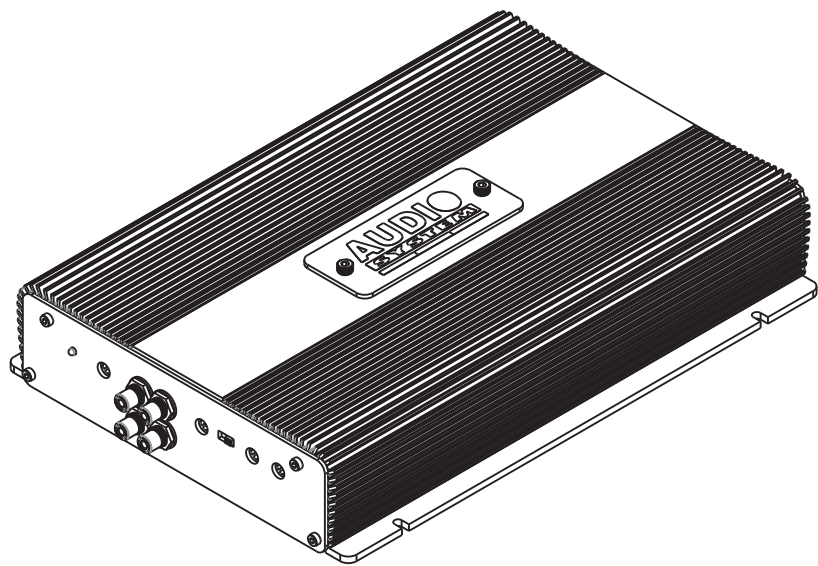

L×W×H:317mm×210mm×54mm

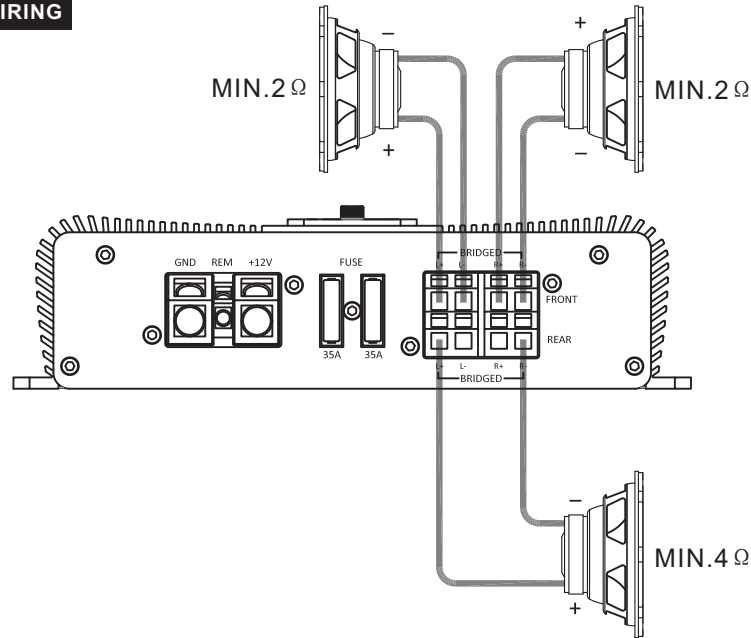
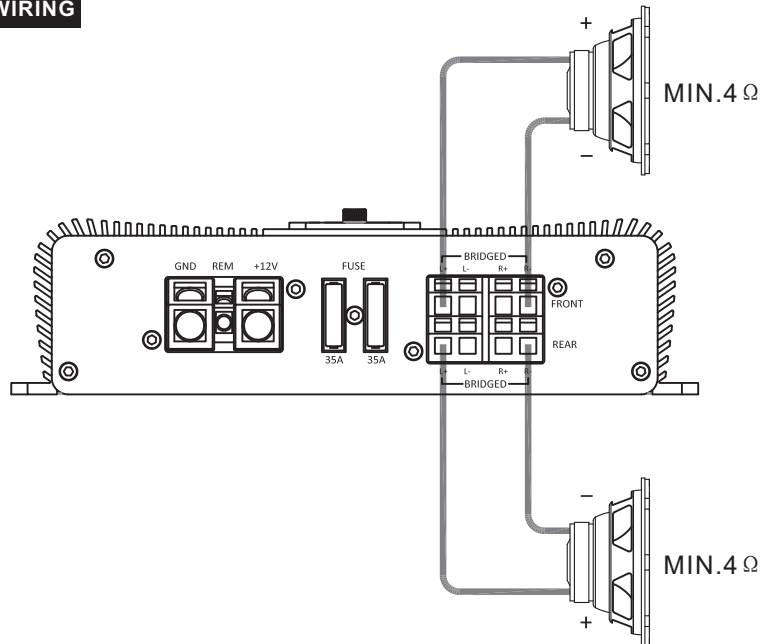
GB**ASS90.4 3Ch WIRING****GB****ASS90.4 2Ch WIRING****中文****注意事项**

- 如果将功放安装到驾驶室，请尽量注意。
- 仅在带有12伏负极接地的汽车中使用。
- 在接线之前，请断开电池与负极电缆的连接，以避免短路或触电。建立正确的连接。
- 由于容量不足，请勿将功放的正极和负极电缆连接到汽车的原有电缆。
- 钻孔时不要损坏管道或接线。
- 安排布线，不要让线割伤或被尖锐的金属边缘夹住。
- 请勿将功放安装在可能阻碍车辆操作的地方，也不要安装在有水气的地方。
- 使用功放随附的安装材料。
- 请勿在制动器，安全气囊或其他安全相关系统中使用螺栓或螺母进行接地连接。
- 警告！功放可能产生超过导致听力损失阈值的声压级。也可能会损害驾驶员听到交通声音或紧急车辆声音的能力。使用音响系统时，请注意安全听音。
- 当功放在特殊艰难的环境下工作时，其温度可以高达90°C。在触摸之前确保其温度的安全。该功放仅适用于机动车辆。

GB**PRECAUTIONS**

- Pay utmost attention if you install the amplifier into the driver's compartment.
- Use Only in cars with a 12 Volt negative ground.
- Before wiring, disconnect the cable from the negative battery terminal to avoid short circuits or electrical shocks. Make the correct connections.
- Do not connect the positive and negative cable of the amplifier to the original cables of the car because of its low capacity.
- Do not damage pipe or wiring when drilling holes.
- Arrange the wiring so it is not crimped or pinched by a sharp metal edge
- Do not install the amplifier in locations which might hinder vehicle operations and do not install in locations with any moisture. Use the installation materials provided with the amplifier.
- Do not use bolts or nuts in the brake, airbags or other safety relevant systems to make ground connections.
- Warning! Amplifiers may produce sound pressure levels that exceed the threshold at which hearing loss may result. They may also impair a driver's ability to hear traffic sounds or emergency vehicles. Practice safe listening when listening to your audio system.
- When the amplifier works in particularly hard conditions, it can research up to 90 °C . Make sure its temperature is safe before touching it. This amplifiers are developed for motor vehicle use only .

GB**ASS90.4 TECHNICAL SPECIFICATIONS****中文****ASS90.4 技术规格****Power Supply****电源**

Power Supply voltage	电源电压	:8-16 VDC
----------------------	------	-----------

Amplifier Stage**功放极**

Output power (RMS) @ 14.4V / 4 Ω	输出功率(RMS) @ 14.4V / 4 Ω	:90 Watt x 4
----------------------------------	-------------------------	--------------

Output power (RMS) @ 14.4V / 2 Ω	输出功率(RMS) @ 14.4V / 2 Ω	:130 Watt x 4
----------------------------------	-------------------------	---------------

Bridged Output power (RMS) @ 14.4V / 4 Ω	桥接输出功率(RMS) @ 14.4V / 4 Ω	:300 Watt x 2
--	---------------------------	---------------

Output power (max) @ 14.4V / 4 Ω	输出功率(最大) @ 14.4V / 4 Ω	:125 Watt x 4
----------------------------------	------------------------	---------------

Output power (max) @ 14.4V / 2 Ω	输出功率(最大) @ 14.4V / 2 Ω	:180 Watt x 4
----------------------------------	------------------------	---------------

Bridged Output power (max) @ 14.4V / 4 Ω	桥接输出功率(最大) @ 14.4V / 4 Ω	:420 Watt x 2
--	--------------------------	---------------

Distorion (THD)	失真度	:<0.1% 4Ω / 45W
-----------------	-----	-----------------

S/N Ratio	信噪比	:>95dB 额定功率
-----------	-----	-------------

Input sensivity	输入灵敏度	:200mV-5V
-----------------	-------	-----------

Filters**滤波器**

AP filter / slope	直通滤波器	:25Hz-20KHz
-------------------	-------	-------------

Low pass filter / slope	低通滤波器/斜率	:50Hz-200Hz/12dB
-------------------------	----------	------------------

High pass filter / slope	高通滤波器/斜率	:50Hz-200Hz/12dB
--------------------------	----------	------------------

Bass Boost Frequency	低音提升频率	:0-6dB / 40Hz
----------------------	--------	---------------

Other Functions**其它功能**

Max size (WxHxL)	最大尺寸 (WxHxL)	:317 x 210 x 54mm
------------------	--------------	-------------------

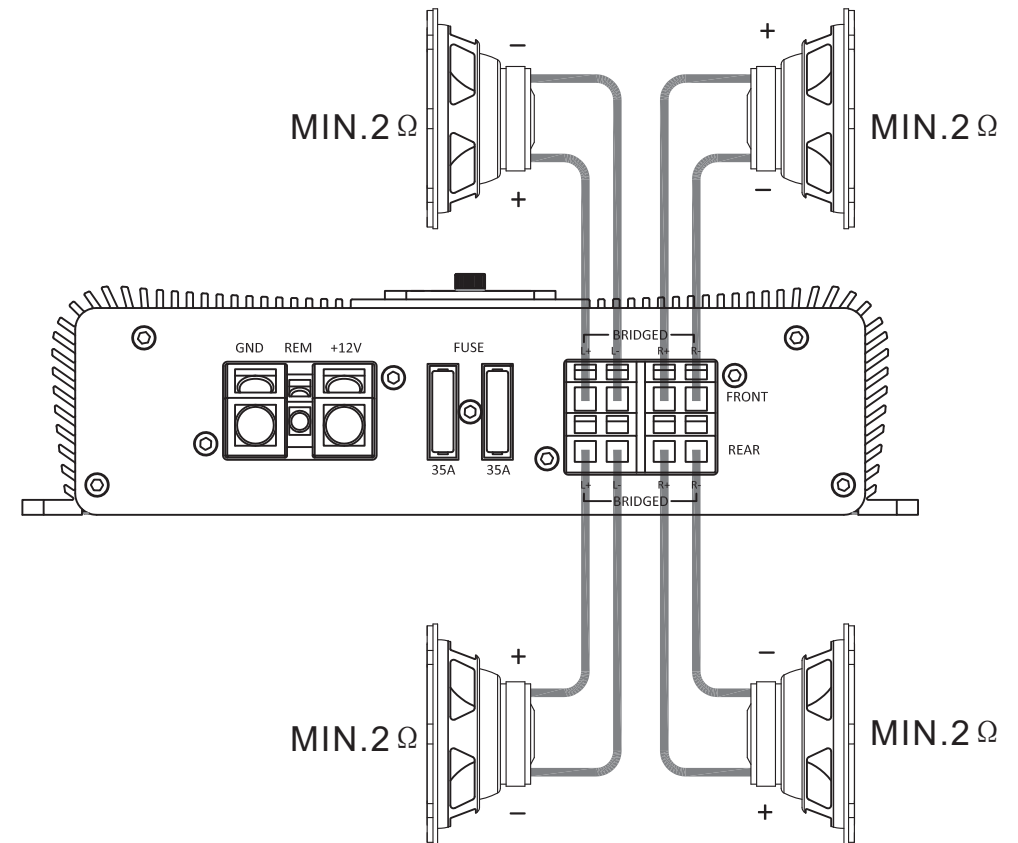
GB**ASS90.4 4Ch WIRING**

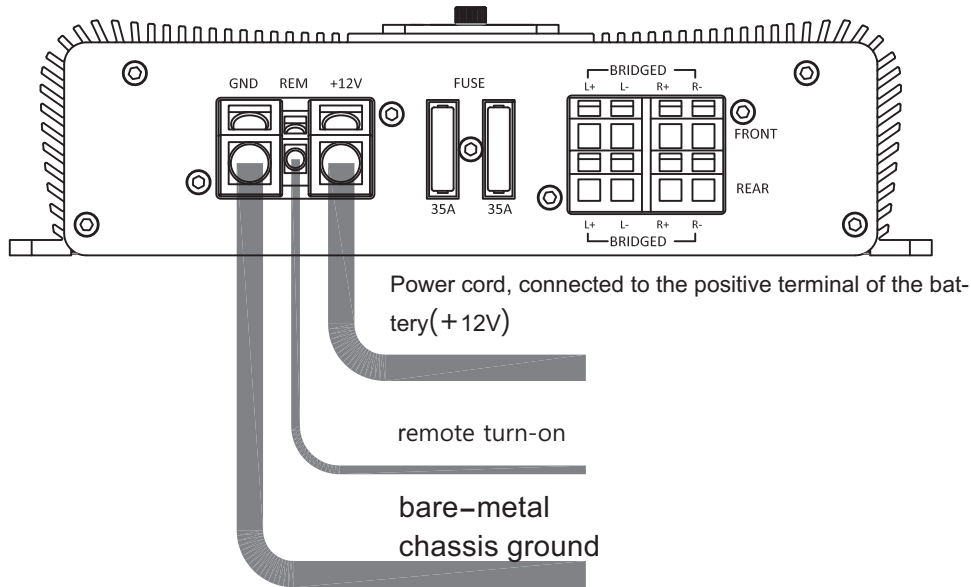

Power/Ground Wire 8AWG

1.  LED指示灯
 当此灯为蓝色时, 功放正常工作。
 当此灯为红色时, 功放进入保护状态, 有可能是温度过热保护、欠压保护、输出短路保护。
2.  AMP1音量控制旋钮
 MIN: 当旋钮指向些位置时, 声音最小。
 MAX: 当旋钮指向些位置时, 声音最大。
3.  RCA信号输入:
 用信号线连接汽车上的主设备 (AM/FM/CD) 输出端。
4.  AMP2音量控制旋钮
 MIN: 当旋钮指向些位置时, 声音最小。
 MAX: 当旋钮指向些位置时, 声音最大。
5.  直通、高通、低通选择开关
 FULL: 直通选择。
 HI: 高通选择。
 LO: 低通选择。
6.  高通、低通频响旋钮
 50Hz: 当旋钮指向些位置时, 频响为50Hz
 200Hz: 当旋钮指向些位置时, 频响为200Hz
7.  提升旋钮
 当旋转此旋钮时, 声音在40Hz提升0-6dB

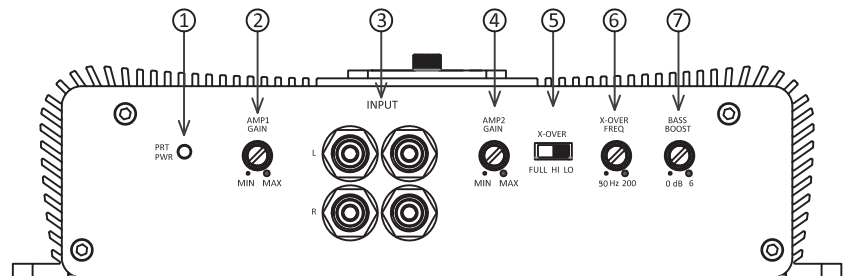

中文

ASS90.4 后面板

1. 电源终端

GND: 连接GND端子/机箱接地。

建议用8AWG电缆。

REM: 远程开机控制

将远程终端连接到您音响主机的远程输出。

+12:

建议用8AWG线连接此处与汽车蓄电池的正极。

2. FUSE: 保险丝座

功放上装有2个35A保险丝。

3. 扬声器终端

将(+)和(-)端子连接到扬声器上, 确保极性正确。具体接法见接线图。

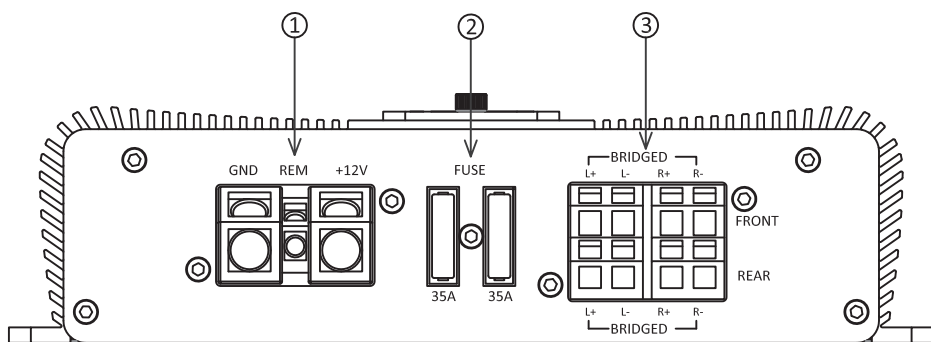

GB

ASS90.4 REAR PANEL

1. Power terminal

GND: Connect the GND terminal/chassis ground.

Please use 8AWG cable. Please refer to the wiring diagram for the length of the ground wire.

REM: Remote boot control

Connect the remote terminal to the remote output of your head unit. When using high level input, once the machine receives the signal, the power amplifier will automatically turn on (TURN ON). The remote connection of the power terminal (REM) will not be used.

+12:

It is recommended to use an 8AWG wire to connect here with the positive pole of the car battery.

2. Fuse Holder

Two 35A fuses are installed on the power amplifier.

3. Speaker terminal

Connect the (+) and (-) terminals to the speaker, making sure the polarity is correct. See the wiring diagram for specific connections.

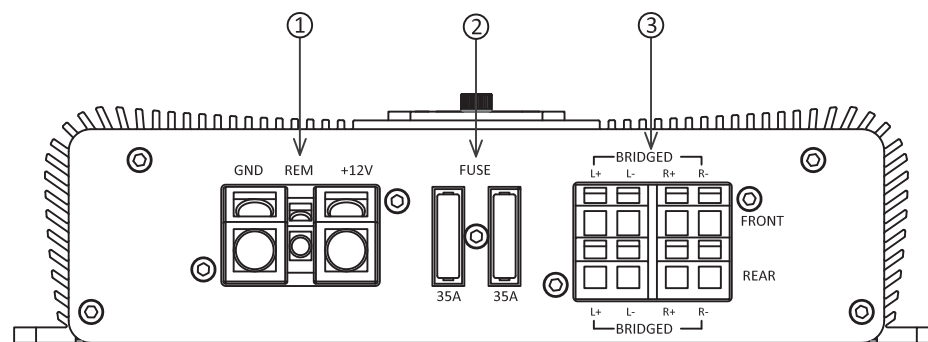

GB

ASS90.4 FRONT PANEL

- 1. Power-on indicator (PWE/PRO)**
 Blue LED on: Power amplifier working normally.
 Red LED on: Power amplifier went into protection status.
 (It could be over heating protection, under voltage protection or output short circuit protection.)
- 2. AMP1 Gain control**
 This control allows you to adjust the overall volume output level, with Min decreasing the volume, and Max increasing.
- 3. RCA Signal Input**
 Connect the output terminals of major device (AM / FM / CD) on vehicles by using signal cables.
- 4. AMP2 Gain control**
 This control allows you to adjust the overall volume output level, with Min decreasing the volume, and Max increasing.
- 5. X-OVER**
 At HI: it means high pass.
 At FULL: it means full range.
 At LO: it means low pass.
- 6. High pass, low pass frequency response knob**
 50Hz: When the knob points to some positions, the frequency response is 50Hz
 200Hz: When the knob points to some positions, the frequency response is 200Hz
- 7. Bass boost**
 The variable bass boost control is designed to give you increased output, 0-6dB , at 40 Hz.

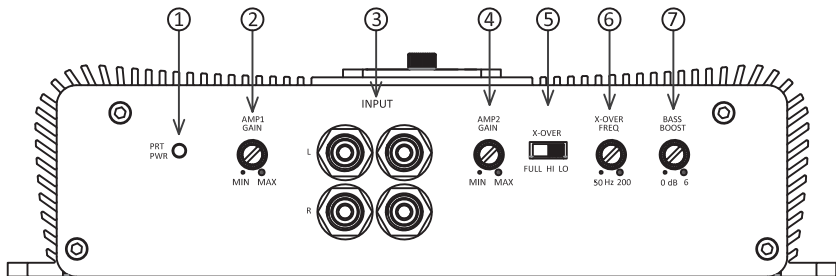

中文

ASS90.4 电源接线图

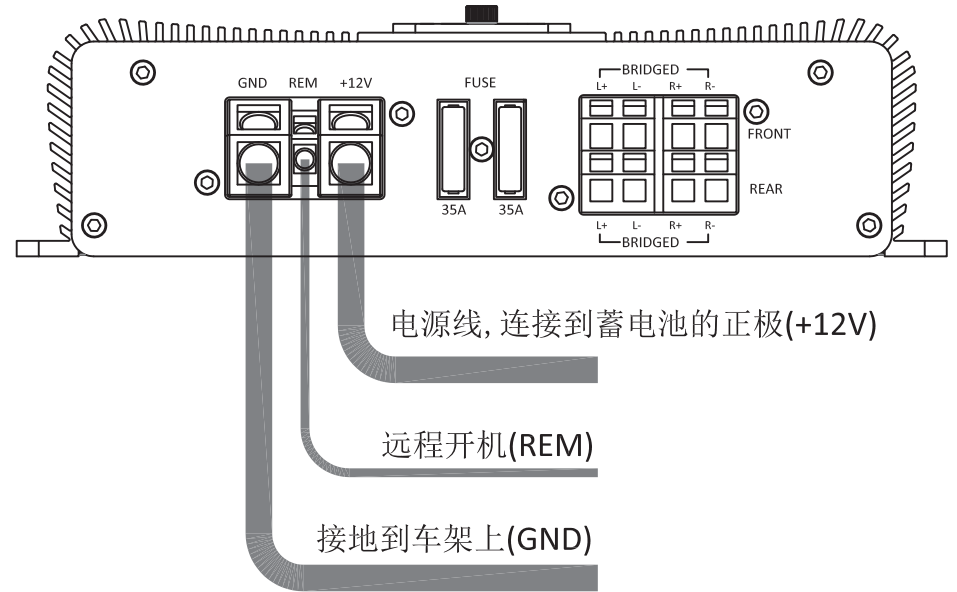

电源线与接地线请用8AWG电缆

中文

ASS90.4 4声道接法

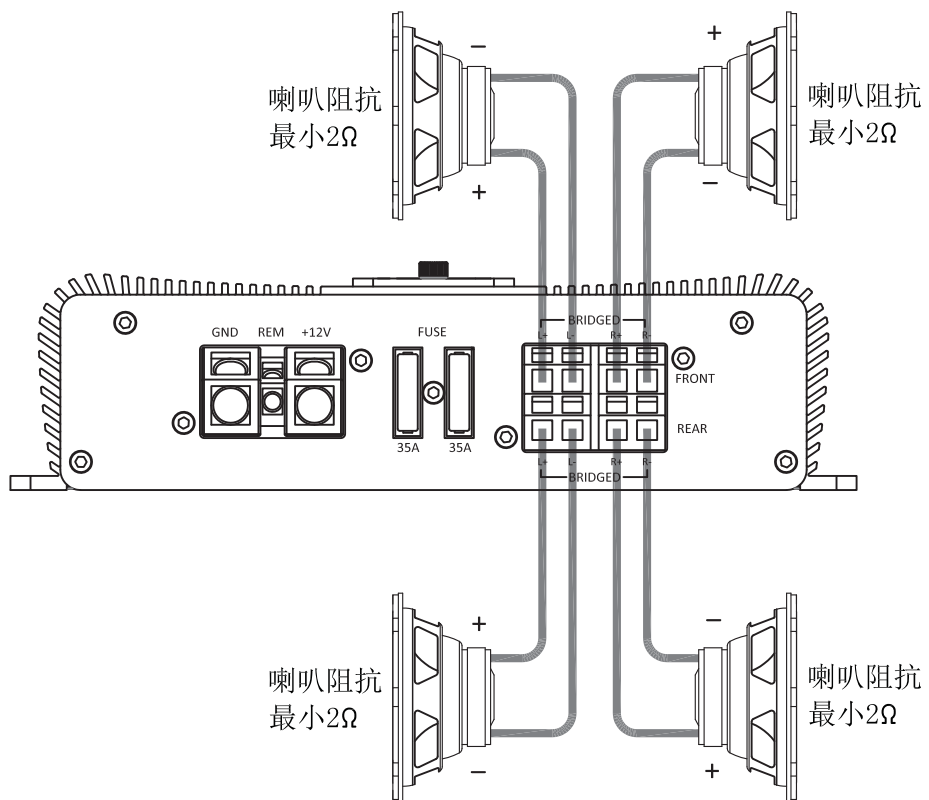

中文

ASS90.4 3声道接法

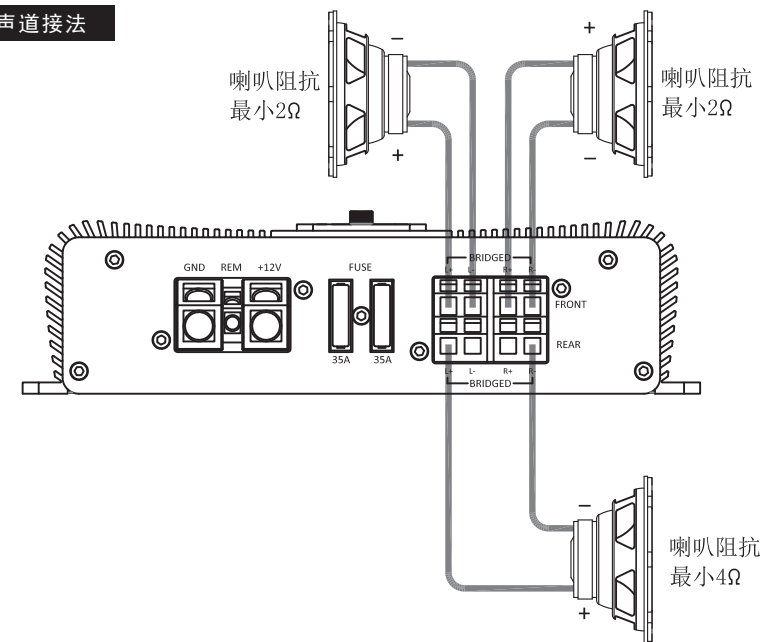

中文

ASS90.4 2声道接法

